

Valves

Our complete range of valves offers installers and specifiers the choice they are looking for to suit most applications, commercial or domestic.

Available in brass, brass chrome, nickel plate and bronze, depending upon product type, our range is manufactured under ISO9001 quality management to the highest British standards and tested to ensure reliability and performance.

The Valve series includes isolating valves, service valves, gate valves, check valves, ball valves, angle valves amongst others in full sizes ranges.

Gate valve ranges are WRAS approved and are manufactured to meet UK and international standards, BS 5154. Compression ends on the valves supplied are manufactured and tested to meet UK and international standards, BS EN 1254-2.

To ensure quality and performance materials used to manufacture the valves range meet the following, appropriate standards:

Forged Brass: BS EN 12165: CW617N

Brass Bar: BS EN 12163, BS EN 12164, BS EN 12167: CW614N

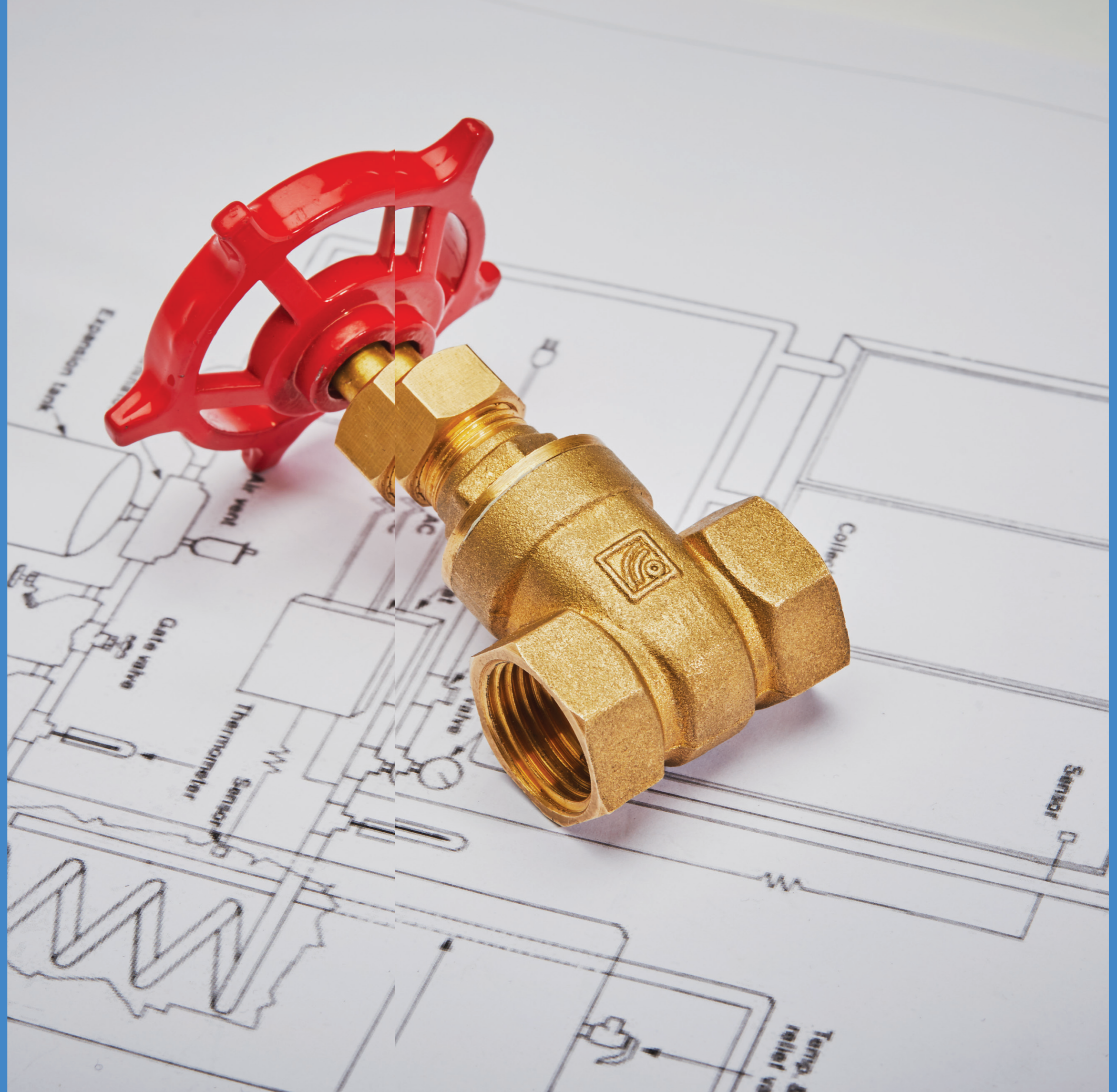

 Valve Fittings Index

Gate Valves



Code: **P474**
Page



Code: **L198**
Page



Code: **L196**
Page



Code: **L197**
Page



Code: **L198LS**
Page



Code: **P474LS**
Page 9

Ball Valves



Code: **811**
Page



Code: **711**
Page



Code: **611**
Page



Code: **PX811**
Page

Float Valves



Code: **BVV**
Page

 Valve Fittings Index

Angle Valves



Code: **AV100.1**
Page



Code: **AV102.1**
Page



Code: **AV103.1**
Page



Code: **AV103.1HC**
Page



Code: **AV104.1**
Page 1



Code: **AV105.1**
Page



Code: **AV106.1**
Page

Mini Ball Valves



Code: **FTH4392CP**
Page



Code: **FTH4402CP**
Page



Code: **FTH4412CP**
Page



Code: **FCP4422CP**
Page



Code: **FCP4372CP**
Page

Pressure Reducer



Code: **FTH4891NP**
Page

Bib Tap



Code: **L480**
Page

Foot Valve

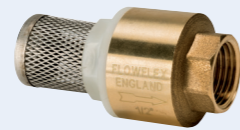

Code: **SPF**
Page

Spring Check Valve

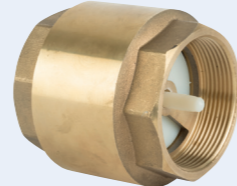

Code: **SPV**
Page

Stop Cock



Code: **P460**
Page 130

Isolation Valves

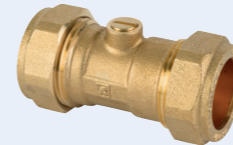

Code: **P472**
Page



Code: **P472CP**
Page



Code: **P472BH**
Page

Ball Type Pump Valve



Code: **MPF.PV**
Page

P474 Gate Valve CxC

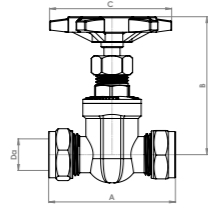

5
Year Warranty

General Specification

Manufactured to: BS 5154
 Compression Ends: BS EN1254-2
 Working Medium: Water
 Pressure Rating: PN16
 Max Working Temperature: Up to 120°C
 Non Rising Stem

Material Specification

Part	Material	Part	Material
Body	Brass CW617N	Gland	Brass CW614N
Bonnet	Brass CW617N	Handwheel	Aluminium
Stem	Brass CW614N	Handwheel Nut	Brass CW614N
Wedge	Brass CW617N	Rating Disc	Aluminium

Product Codes & Dimensions

Code	Size (Ga)	A	B	C
P474.1	15mm	34	70	58
P474.2	22mm	47	70	58
P474.3	28mm	54	85	63
P474.4	35mm	69	110	80
P474.5	42mm	76	130	92
P474.6	54mm	102	165	105

L198 Gate Valve FxF

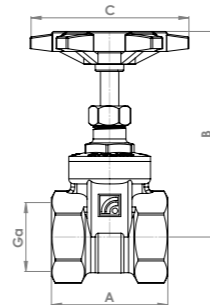

5
Year Warranty

General Specification

Manufactured to: BS 5154
 Working Medium: Water
 Pressure Rating: PN20
 Non Rising Stem

Pressure / Temperature Rating:

20 Bar @ -10°C to 100°C
 9 Bar @ 100°C to 180°C

Material Specification

Part	Material	Part	Material
Body	Brass CW617N	Handwheel	Aluminium
Bonnet	Brass CW617N	Handwheel Nuts	Brass CW614N
Stem	Brass CW614N	Rating Disc	Aluminium
Wedge	Brass CW617N	Seal	PTFE
Gland	Brass CW614N		

Product Codes & Dimensions

Code	Size (Ga)	A	B	C
L198.1	1/2"	40	70	58
L198.2	3/4"	70	79	66
L198.3	1"	84	91	65
L198.4	1 1/4"	87	106	80
L198.5	1 1/2"	112	127	95
L198.6	2"	63	144	105
L198.7	2 1/2"	69	196	115
L198.8	3"	80	213	145
L198.9	4"	102	240	145

L196 Gate Valve FxF

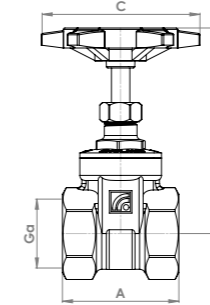

5
Year Warranty

General Specification

Manufactured to: BS 5154
 Working Medium: Water, Oil, Steam
 Pressure Rating: PN20
 Non Rising Stem
 Corrosive Resistant

Pressure / Temperature Rating:

Max Working Temperature: Up to 120°C
 Hot Water: 9 Bar @ 120°C
 Cold Water: 20 Bar @ 100°C

Material Specification

Part	Material	Part	Material
Nut	Brass CW614N	Bonnet	Bronze CC491K
Name Plate	Aluminium	Lock Nut	Brass CW614N
Handwheel	Aluminium	Sealing	PTFE
Press Nut	Brass CW614N	Stem	Brass CW614N
Brass Ring	Brass CW614N	Board	Bronze CC491K
Plastic Ring	PTFE	Body	Bronze CC491K

Product Codes & Dimensions

Code	Size (Ga)	A	B	C
L196.1	1/2"	49	75	55
L196.2	3/4"	50	87	55
L196.3	1"	57	101	63
L196.4	1 1/4"	60	108	70
L196.5	1 1/2"	63	125	70
L196.6	2"	66	154	80
L196.7	2 1/2"	88	192	90
L196.8	3"	96	201	140
L196.9	4"	106	243	140

L197 Brass Gate Valve CxC

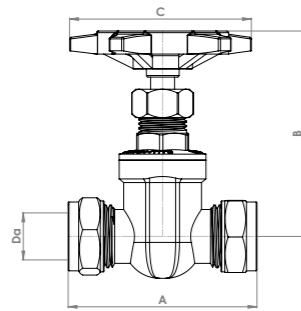

5
Year Warranty

General Specification

Manufactured to: BS 5154
 Compression Ends: BS EN1254-2
 Working Medium: Water
 Pressure Rating: PN16
 Max Working Temperature: Up to 99°C
 Non Rising Stem

Material Specification

Part	Material	Part	Material
Body	Brass CW617N	Seal	PTFE
Bonnet	Brass CW617N	Handwheel	Aluminium
Stem	Brass CW614N	Handwheel Nut	Brass CW614N
Wedge	Brass CW617N	Olive	Brass CW614N
Gland	Brass CW614N		
Nuts	Brass CW617N		

Product Codes & Dimensions

Code	Size (Da)	A	B	C
L197.1	15mm	106	80	60
L197.2	22mm	127	85	65
L197.3	28mm	49	93	65
L197.4	35mm	50	121	80
L197.5	42mm	57	141	100
L197.6	54mm	60	164	110

L197 Large Brass Gate Valve CxC

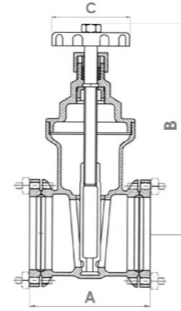
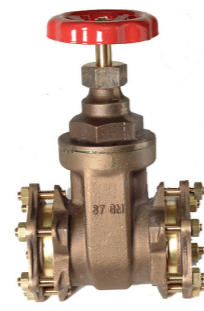

5
Year Warranty

General Specification

Temperature Pressure:
 10 Bar @ 30°C
 3 Bar @ 120°C

Material Specification

Part	Material	Part	Material
Body	Gunmetal	Packing flange and bolts	Gunmetal
Bonnet	Gunmetal	Handwheel	Aluminium
Stem	Gunmetal	Nameplate	Aluminium
Gland nut	Brass	Handle screw	Steel
Gland	Brass	Compression cone	Brass

Product Codes & Dimensions

Code	Size (Da)	A	B	C
L197.7	67mm	131	208	100
L197.8	76mm	149	238	120
L197.9	108mm	194	309	200

L198LS Brass Lockshield Gate Valve FxF

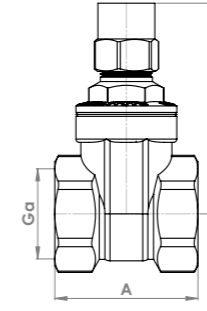

5
Year Warranty

General Specification

Manufactured to: BS 5154
 Pressure Rating: PN20
 Lockshield Key for Safety
 Non Rising Stem
Pressure / Temperature Rating:
 20 Bar @ -10°C to 100°C
 9 Bar @ 100°C to 180°C

Material Specification

Part	Material	Part	Material
Gate Housing	Brass CW617N	Drive Column	Brass CW614N
Gate	Brass CW614N	Housing Cap	Brass CW617N
Housing Seal	PTFE M139	Washer	PTFE M139
Column Lock	Brass CW614N	Lockshield	Brass CW617N
Column Washer	Brass CW614N		

Product Codes & Dimensions

Code	Size (Ga)	A	B
L198LS.1	1/2"	40	62
L198LS.2	3/4"	44	69
L198LS.3	1"	55	78

P474LS Lockshield Gate Valve CxC

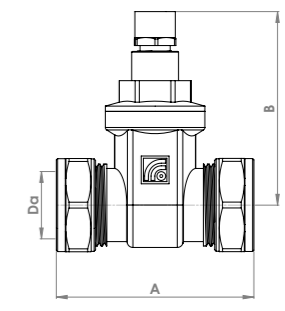

5
Year Warranty

General Specification

Manufactured to: BS 5154
 Compression Ends: BS EN 1254-2
 Pressure Rating: PN16
 Max Working Temperature: Up to 120°C
 Lockshield Key for Safety
 Non Rising Stem

Material Specification

Part	Material	Part	Material
Housing	Brass CW617N	Housing Cap	Brass CW617N
Gate	Brass CW617N	Washer	PTFE
Housing Steel	PTFE	Lockshield	Brass CW614N
Column Lock	Brass CW617N	Olive	Copper
Column Washer	Brass CW617N	Nut	Brass CW617N
Drive Column	Brass CW614N		

Product Codes & Dimensions

Code	Size (Da)	A	B
P474LS.1	15mm	31	60
P474LS.2	22mm	33	67
P474LS.3	28mm	33	67

FLSKEY.1 Lockshield Gate Valve Key



Code	Size
FLSKEY.1	One Size

Ball Valves - Red Lever Arm Handle

811 FxF Lever Arm Ball Valve Red Handle

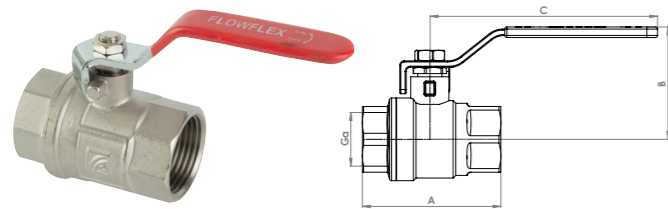

5
Year Warranty

General Specification

Pressure Rating: PN30
Working Temperature: -20°C to 120°C
Quarter Turn Operation

Material Specification

Part	Material
Body	Brass CW617N nickel-plated
Ball	Brass CW614N chrome-plated
Stem	Brass CW614N nickel-plated
Seat	PTFE
Friction Washer	PTFE
O-Ring	Nitrile butadiene rubber (NBR)
Lever	Steel chrome-plated
Handle Nut	Steel chrome-plated

Product Codes & Dimensions

Code	Size (Ga)	A	B	C
8111	1/2"	46	40	85
8112	3/4"	53	47	85
8113	1"	61	62	99
8114	1 1/4"	72	75	117
8115	1 1/2"	84	82	117
8116	2"	94	87	132
8117	2 1/2"	119	119	235
8118	3"	142	127	235
8119	4"	169	142	235

711 CxC Lever Arm Ball Valve Red Handle

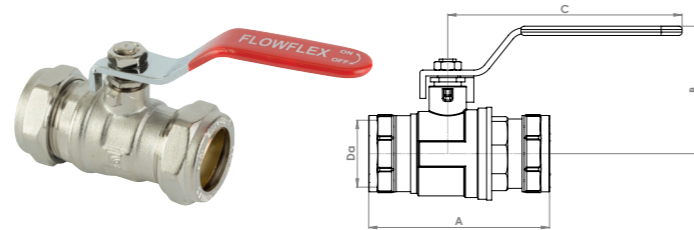

5
Year Warranty

General Specification

Compression Ends: BS EN1254-2
Pressure Rating: PN30
Working Temperature: -20°C to 120°C
Quarter Turn Operation

Material Specification

Part	Material
Body	Brass CW617N nickel-plated
Ball	Brass CW614N chrome-plated
Stem	Brass CW614N nickel-plated
Seat	PTFE
Friction Washer	PTFE
O-Ring	Nitrile butadiene rubber (NBR)
Lever	Steel chrome-plated
Handle Nut	Steel chrome-plated

Product Codes & Dimensions

Code	Size (Da)	A	B	C
7111	15mm	62	45	85
7112	22mm	69	49	85
7113	28mm	85	63	127
7114	35mm	109	76	139
7115	42mm	125	94	139
7116	54mm	141	99	160
7117	18mm	74	50	83

Ball Valves - Butterfly Handle

611 Compression Butterfly Handle Ball Valve

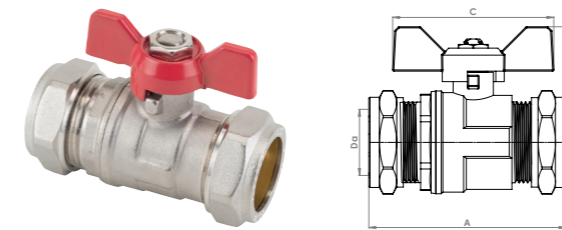

5
Year Warranty

General Specification

Compression Ends: BS EN 1254-2
Pressure Rating: PN20
Working Temperature: -20°C to 120°C
Quarter Turn Operation

Material Specification

Part	Material
Body	Brass CW617N nickel-plated
Ball	Brass CW614N chrome-plated
Stem	Brass CW614N nickel-plated
Seat	PTFE
Friction Washer	PTFE
O-Ring	Nitrile butadiene rubber (NBR)
Lever	Lacquered aluminium
Handle Nut	Steel chrome-plated

Product Codes & Dimensions

Code	Size (Ga)	A	B	C
6111	15mm	62	45	50
6112	22mm	71	36	52
6113	28mm	83	46	68
6117	18mm	70	45	50

PX811 Mi x Fi Union Ball Valve

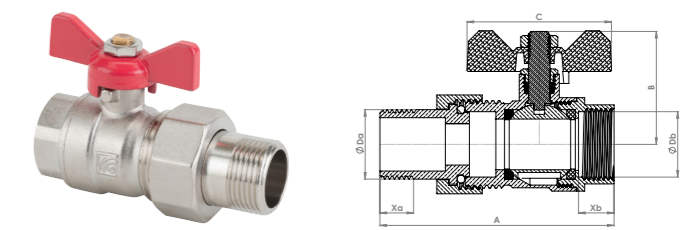

5
Year Warranty

General Specification

Threads: ISO 228
Pressure Rating: PN40
Working Temperature: -10°C to 95°C
Used with PEX system & Manifolds
Quarter Turn Operation
Red & Blue Handles

Material Specification

Part	Material
Body	Brass CW617N nickel-plated
Seal	PTFE
Ball	Brass CW617N chrome-plated
End Connection	Brass CW617N nickel-plated
Stem	Brass CW617N
Gland Packing	PTFE Carbon Filled
Gland	Brass CW617N
Nut	Galvanised Iron
Handle	Galvanised Iron PVC Coated

Product Codes & Dimensions

Code	Handle	Size	A	B	C	Xa	Xb
PX8112	Red Butterfly	3/4"	86	44	57	13	12
PX8113	Blue Butterfly	3/4"	86	44	57	13	12

BVV MOH Brass Float Valve

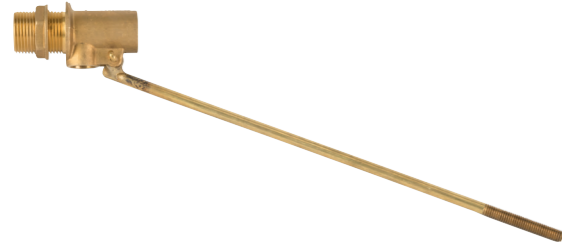

5
Year Warranty

General Specification

Pressure Rating: PN14
Working Temperature: 0°C to 85°C

Material Specification

Part	Material	Part	Material
Body	Brass CW617N	Flange Nut	Brass CW614N
Washer	EPDM	Nut	Brass CW614N
Float Arm	Brass CW617N	Shuttle	Brass CW614N

Product Codes & Dimensions

Code	Size (Ga)	A	B	C	Xa
BV.11	1/2"	76	31	268	31
BV.12	3/4"	81	35	366	33
BV.13	1"	92	49	42	38
BV.14	1 1/4"	105	49	466	48
BV.15	1 1/2"	111	58	480	49
BV.16	2"	123	69	514	50

Code	Size (Ga)	Seat Bore	Tail Length	Lever Size	Float size
BV.11	1/2"	1/8"	1 1/4"	10 x 5/16"	4 1/2" x 5/16"W
BV.12	3/4"	1/4"	1 1/2"	13 x 5/16"	5" x 5/16"W
BV.13	1"	3/8"	1 1/2"	14 x 3/8"	6" x 3/8"W
BV.14	1 1/4"	1/2"	2"	17 x 3/8"	8" x 3/8"W
BV.15	1 1/2"	5/8"	2"	21 x 1/2"	10" x 1/2"W
BV.16	2"	5/8"	2"	21 x 1/2"	10" x 1/2"W

BVV MOH Brass Float Valve

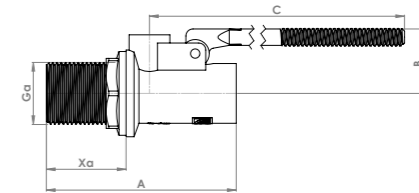
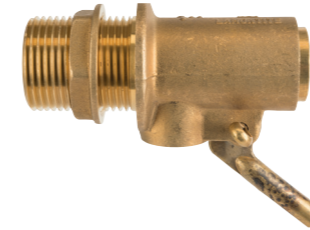

Flow Rate & Size Selection Chart (GPM)

	1/2"	3/4"	1"	1 1/4"	1 1/2"	2"
	0.25	0.82	1.85	2.50	5.90	11.70
	0.35	1.16	2.60	3.50	8.30	16.50
	0.50	1.65	3.70	4.90	11.80	23.50
	0.70	2.33	5.20	6.90	16.60	33.70
	0.93	3.10	6.90	9.20	21.90	43.10
	1.10	3.70	8.20	11.00	26.30	52.50
	1.40	4.50	10.10	13.50	32.30	64.40
	1.60	5.20	11.70	15.60	37.30	74.40
	1.76	5.80	13.00	17.40	41.60	83.10
	1.93	6.40	14.30	19.10	45.60	91.00
	2.10	6.90	15.40	20.60	49.20	98.30
	2.20	7.40	16.50	22.00	52.60	105.00

BVF Float for Ball Valves



Code	Float Size
BVF.19	4 1/2" x 5/16" W
BVF.20	5" x 5/16" W
BVF.21	6" x 3/8" W
BVF.22	8" x 3/8" W
BVF.23	10" x 1/2" W

AV100.1 Angle Valves

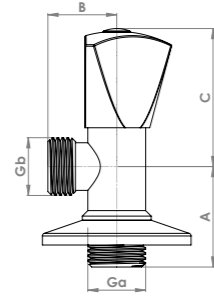

5
Year Warranty

General Specification

1/2" x 1/2" Angle Valve with Tricorn Handle and Hot / Cold Indicator

Maximum Working Pressure: 10 Bar
Maximum Operating Temperature: 100°C

Product Codes & Dimensions

Code	Size (Ga, Gb)	A	B	C
AV100.1	1/2" x 1/2"	38	25	46

Material Specification

Part	Material
Body	Brass Chrome-plated (CW617N)
Bushing	Brass (CW614N)
Press Cap	Brass (CW614N)
Tricorn Handle	Zinc alloy Chrome-plated
Rosette	Stainless Steel AISI 304
Spindle Screw	Brass (CW614N)
Red / Blue Cap	ABS Plastic
Clip	Stainless Steel AISI 304
O Ring	N8118F Black coloured Nitrile (Acrylonitrile Butadiene) Shore hardness 80 in radius size 2.80mm.
O Ring	N7118F Black coloured Nitrile (Acrylonitrile Butadiene) Shore hardness 70 in radius size 0.95mm.
O Ring	N7118F Black coloured Nitrile (Acrylonitrile Butadiene) Shore hardness 70 in radius size 0.95mm.

AV102.1 Angle Valves

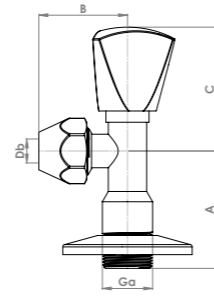

5
Year Warranty

General Specification

1/2" x 1/2" (10mm) Angle Valve with Tricorn Handle and 10mm Compression Nut

Maximum Working Pressure: 10 Bar
Maximum Operating Temperature: 100°C

Product Codes & Dimensions

Code	Size (Ga, Db)	A	B	C
AV102.1	1/2" x 1/2" (10mm)	45	34	54

Material Specification

Part	Material
Body	Brass Chrome-plated (CW617N)
Spindle	Brass (CW614N)
Tricorn Handle	Zinc alloy Chrome-plated
Thrust Washer	Stainless Steel AISI 304
O Ring	N8118F Black coloured Nitrile (Acrylonitrile Butadiene) Shore hardness 80 in radius size 1.40mm.
O Ring	N7118F Black coloured Nitrile (Acrylonitrile Butadiene) Shore hardness 70 in radius size 0.95mm.
Rosette	Stainless Steel AISI 304
Compression Nut	Brass Chrome-plated (CW614N)
Olive	Brass (CW614N)

AV103.1 Angle Valves

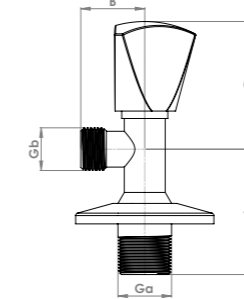

5
Year Warranty

General Specification

1/2" x 3/8" Angle Valve with Tricorn Handle and 3/8" Outlet

Maximum Working Pressure: 10 Bar
Maximum Operating Temperature: 100°C

Product Codes & Dimensions

Code	Size (Ga, Gb)	A	B	C
AV103.1	1/2" x 3/8"	48	25	53

Material Specification

Part	Material
Body	Brass Chrome-plated (CW617N)
Spindle	Brass (CW614N)
Tricorn Handle	Zinc alloy Chrome-plated
Thrust Washer	Stainless Steel AISI 304
O Ring	N8118F Black coloured Nitrile (Acrylonitrile Butadiene) Shore hardness 80 in radius size 1.40mm.
O Ring	N7118F Black coloured Nitrile (Acrylonitrile Butadiene) Shore hardness 70 in radius size 0.95mm.
Rosette	Stainless Steel AISI 304

AV103.1HC Angle Valves

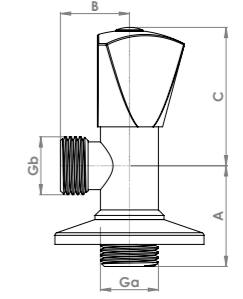

5
Year Warranty

General Specification

1/2" x 3/8" Angle Valve with Tricorn Handle and Hot / Cold Indicator

Maximum Working Pressure: 10 Bar
Maximum Operating Temperature: 100°C

Product Codes & Dimensions

Code	Size (Ga, Gb)	A	B	C
AV103.1HC	1/2" x 3/8"	47	25	43

Material Specification

Part	Material
Body	Brass Chrome-plated
Spindle	Brass Chrome-plated
Tricorn Handle	Zinc Chrome-plated
Thrust Washer	AISI 304 Stainless steel
O Ring	N8118F Black coloured Nitrile (Acrylonitrile Butadiene) Shore hardness 80 in radius size 1.40mm.
O Ring	N7118F Black coloured Nitrile (Acrylonitrile Butadiene) Shore hardness 70 in radius size 0.95mm.
Rosette	Steel Chrome-plated
Screw	Brass Chrome-plated
Red / Blue Cap	ABS Plastic

AV104.1 Angle Valves

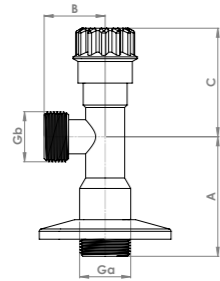

5
Year Warranty

General Specification

1/2" x 1/2" Angle Valve with Multi Rib Handle

Maximum Working Pressure: 10 Bar
Maximum Operating Temperature: 100°C

Product Codes & Dimensions

Code	Size (Ga, Gb)	A	B	C
AV104.1	1/2" x 1/2"	48	25	37

Material Specification

Part	Material
Body	Brass CW617N Chrome-plated
Spindle	Brass CW614N
Rosette	Stainless Steel AISI 304
O Ring	N8118F Black coloured Nitrile (Acrylonitrile Butadiene) Shore hardness 80 in radius size 1.40mm.
O Ring	N7118F Black coloured Nitrile (Acrylonitrile Butadiene) Shore hardness 70 in radius size 0.95mm.
Thrust Washer	Stainless Steel AISI 304
Multi Rib Handle	Plastic Chrome-plated

AV105.1 Angle Valves

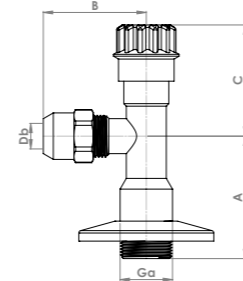

5
Year Warranty

General Specification

1/2" x 3/8" (10mm) Angle Valve with Multi Rib Handle and 10mm Compression Nut

Maximum Working Pressure: 10 Bar
Maximum Operating Temperature: 100°C

Product Codes & Dimensions

Code	Size (Ga, Db)	A	B	C
AV105.1	1/2" x 3/8" (10mm)	48	40	38

Material Specification

Part	Material
Body	Brass CW617N Chrome-plated
Valve	Brass CW614N
Rosette	Stainless Steel AISI 304
O Ring	N8118F Black coloured Nitrile (Acrylonitrile Butadiene) Shore hardness 80 in radius size 1.40mm.
O Ring	N7118F Black coloured Nitrile (Acrylonitrile Butadiene) Shore hardness 70 in radius size 0.95mm.
Thrust Washer	Stainless Steel AISI 304
Multi Rib Handle	Plastic Chrome-plated
Compression Nut	Brass Chrome-plated CW614N
Gasket	N8118F Black coloured Nitrile (Acrylonitrile Butadiene) Shore hardness 80 in radius size 2.00mm.
Split Olive	Brass CW614N

AV106.1 Angle Valves

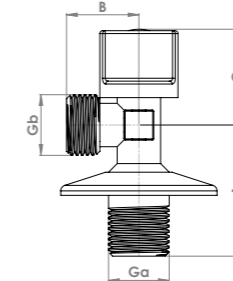

5
Year Warranty

General Specification

1/2" x 1/2" Angle Valve with 1/4 Turn Handle and Hot / Cold Indicator

Maximum Working Pressure: 10 Bar
Maximum Operating Temperature: 100°C

Product Codes & Dimensions

Code	Size (Ga, Gb)	A	B	C
AV106.1	1/2" x 1/2"	45	24	34

Material Specification

Part	Material
Body	Brass CW617N Chrome-plated
Valve	Brass CW614N
O Ring	N8118F Black coloured Nitrile (Acrylonitrile Butadiene) Shore hardness 80 in radius size 1.40mm.
Set Screw	Brass CW614N
Handle	Plastic Chrome-plated
Screw	Brass CW614N
Red / Blue Cap	ABS Plastic
Rosette	Stainless Steel AISI 304
O Ring	N7118F Black coloured Nitrile (Acrylonitrile Butadiene) Shore hardness 70 in radius size 0.95mm.

FTH4392CP Water Ball Valve Black Handle DZR MxF

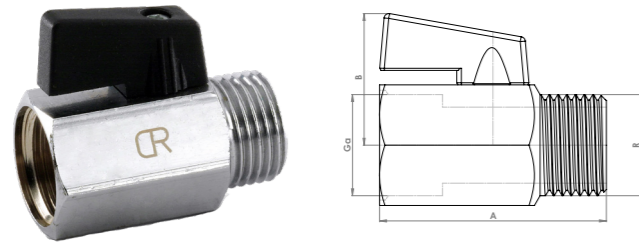

5
Year Warranty

General Specification

Threads: ISO 228
Pressure Rating: PN10
Working Temperature: -10°C to 90°C

Material Specification

Part	Material
Body	DZR Brass CW511L Chrome-plated
Stem	DZR Brass CW511L Nickel-plated
Ball	DZR Brass CW511L Nickel-plated
Ring	DZR Brass CW511L
Seal	PTFE
O-Ring	EPDM perox
Screw	C4C
Black Plastic Lever	Glass-filled NYLON 66

Product Codes & Dimensions

Code	Size (Ga, R)	DN	A	B
FTH4392CP.38	3/8"	10	40	27
FTH4392CP.12	1/2"	15	45	29

FTH4402CP Water Ball Valve Black Handle DZR MxM

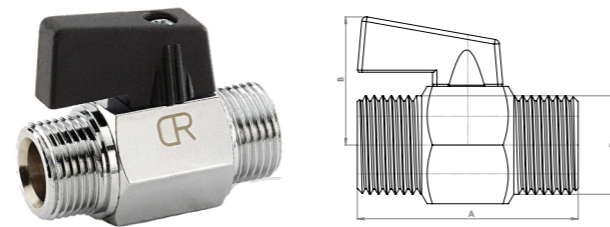

5
Year Warranty

General Specification

Threads: ISO 228
Pressure Rating: PN10
Working Temperature: -10°C to 90°C

Material Specification

Part	Material
Body	DZR Brass CW511L Chrome-plated
Stem	DZR Brass CW511L Nickel-plated
Ball	DZR Brass CW511L Nickel-plated
Ring	DZR Brass CW511L
Seal	PTFE
O-Ring	EPDM perox
Screw	C4C
Black Plastic Lever	Glass-filled NYLON 66

Product Codes & Dimensions

Code	Size (R)	DN	A	B
FTH4402CP.12	1/2" x 1/2"	15	44	28

FCP4412CP Water Ball Valve Black Handle DZR CxF

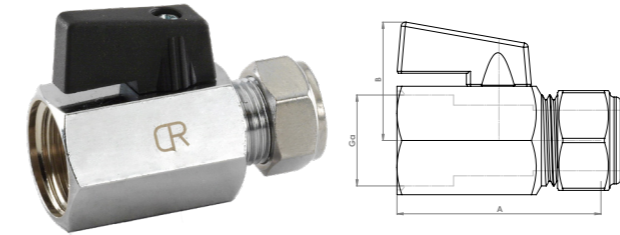

5
Year Warranty

General Specification

Compression End: BS EN1254-2
Thread: ISO 228
Pressure Rating: PN10
Working Temperature: -10°C to 90°C

Material Specification

Part	Material
Body	DZR Brass CW511L Chrome-plated
Nut	DZR Brass CW511L Chrome-plated
Olive	Brass CW508L
Stem	DZR Brass CW511L Nickel-plated
Ball	DZR Brass CW511L Nickel-plated
Ring	DZR Brass CW511L
Seal	PTFE
O-Ring	EPDM perox
Screw	C4C
Black Plastic Lever	Glass-filled NYLON 66

Product Codes & Dimensions

Code	Size (Ga, Da)	DN	A	B
FCP4412CP.1212	12mm x 1/2"	15	53	29
FCP4412CP.1512	15mm x 1/2"	15	53	29

FCP4422CP Water Ball Valve Black Handle DZR CxM

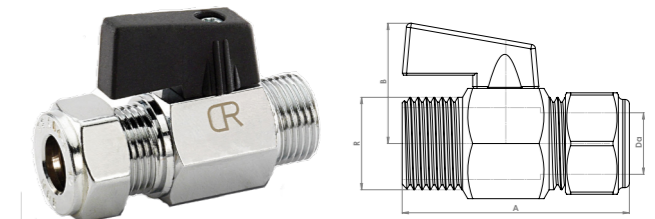

5
Year Warranty

General Specification

Compression End: BS EN1254-2
Thread: ISO 228
Pressure Rating: PN10
Working Temperature: -10°C to 90°C

Material Specification

Part	Material
Body	DZR Brass CW511L Chrome-plated
Nut	DZR Brass CW511L Chrome-plated
Olive	Brass CW508L
Stem	DZR Brass CW511L Nickel-plated
Ball	DZR Brass CW511L Nickel-plated
Ring	DZR Brass CW511L
Seal	PTFE
O-Ring	EPDM perox
Screw	C4C
Black Plastic Lever	Glass-filled NYLON 66

Product Codes & Dimensions

Code	Size (Da, R)	DN	A	B
FCP4422CP.1512	15mm x 1/2"	15	51	28

Mini Ball Valves

FCP4372CP Water Ball Valve Black Handle DZR CxC

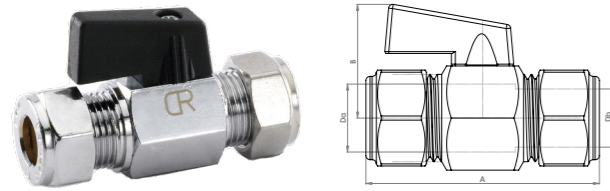

5
Year Warranty

General Specification

Compression End:	BS EN1254-2
Pressure Rating:	PN10
Working Temperature:	-10°C to 90°C

Material Specification

Part	Material
Body	DZR Brass CW511L Chrome-plated
Nut	DZR Brass CW511L Chrome-plated
Olive	Brass CW508L
Stem	DZR Brass CW511L Nickel-plated
Ball	DZR Brass CW511L Nickel-plated
Ring	DZR Brass CW511L
Seal	PTFE
O-Ring	EPDM perox
Screw	C4C
Black Plastic Lever	Glass-filled NYLON 66

Product Codes & Dimensions

Code	Size (Da, Db)	A	B
FCP4372CP.1010	10 x 10mm	59	28
FCP4372CP.1210	12 x 10mm	58	28
FCP4372CP.1212	12 x 12mm	58	28
FCP4372CP.1510	15 x 10mm	58	28
FCP4372CP.1512	15 x 12mm	61	28
FCP4372CP.1515	15 x 15mm	61	28

Pressure Reducing Valve

FTH4891NP Pressure Reducer

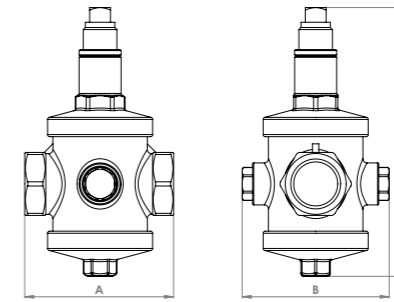

5
Year Warranty

General Specification

Pressure Rating:	PN25	Outlet Pressure adjustable:	0.5 to 7 Bar
Working Temperature:	0°C to 80°C	Factory Set Pressure:	3 Bar
Maximum Inlet Pressure:	16 Bar		

Material Specification

Part	Material	Part	Material
Body	CW617N Brass	Spring	Spring Steel
Cartridge	CW617N Brass	Cap of Spring	CW617N Brass
Gasket	EPDM	Cover	CW617N Brass
O-Ring	EPDM	Plug	Plastic

Product Codes & Dimensions

Code	Size	A	B	C
FTH4891NP.12	1/2"	70	68	123
FTH4891NP.34	3/4"	80	68	123
FTH4891NP.1	1"	85	80	138
FTH4891NP.114	1 1/4"	105	92	156
FTH4891NP.112	1 1/2"	115	92	156
FTH4891NP.2	2"	120	110	175

L480 Bib Tap

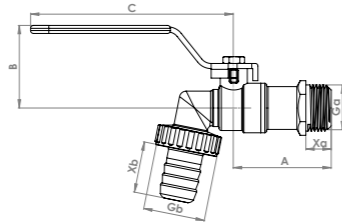

5
Year Warranty

General Specification

Pressure Rating: PN10
 Working Temperature: -20°C to 100°C
 Quarter Turn Operation
 c/w Hose Connection

Material Specification

Part	Material	Part	Material
Body	Brass CW617N nickel-plated	Lever	Steel
Male Threaded Body	Brass CW617N nickel-plated	Sealing Rings	PTFE
Ball	Brass CW614N chrome-plated	Drive Column	Brass CW617N
Washer	Nitrile butadiene rubber (NBR)	Male Tap Piece	AISI 304 stainless steel
Lever Nut	Brass CW614N chrome-plated	Sealing Nut	AISI 304 stainless steel

Product Codes & Dimensions

Code	Size (Ga)	A	B	C	Xa	Xb
L480.2	1/2"	85	40	79	12	21
L480.3	3/4"	104	43	79	13	24
L480.4	1"	116	52	102	14	31

SPF Foot Valve

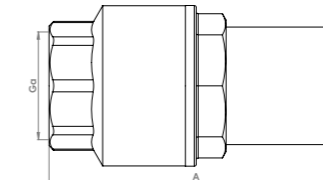

5
Year Warranty

General Specification

Pressure / Temperature Rating: 1/2" to 1" PN10 -20°C to 100°C
 1 1/4" to 2" PN8 -20°C to 90°C
 2 1/2" to 4" PN6 -20°C to 90°C

Material Specification

Part	Material	Part	Material
Body	Brass CW617N	Nut	Nylon
Spring	AISI 304 stainless steel	Mesh	AISI 304 stainless steel
Plunger	Nylon	Washer	Nitrile butadiene rubber (NBR)

Product Codes & Dimensions

Code	Size (Ga)	Max Pressure	A
SPF.1	1/2"	10	69
SPF.2	3/4"	10	78
SPF.3	1"	10	88
SPF.4	1 1/4"	8	106
SPF.5	1 1/2"	8	116
SPF.6	2"	8	140
SPF.7	2 1/2"	6	148
SPF.8	3"	6	177
SPF.9	4"	6	195

SPV Spring Check Valve

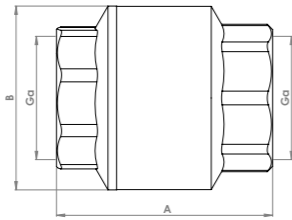
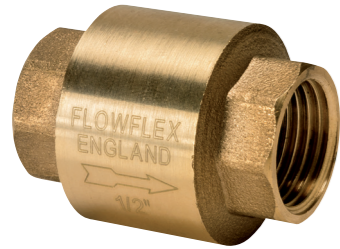

5
Year Warranty

General Specification

Pressure / Temperature Rating:	1/2" to 1"	PN10	-20°C to 100°C
	1 1/4" to 2"	PN8	-20°C to 90°C
	2 1/2" to 4"	PN6	-20°C to 90°C

Material Specification

Part	Material	Part	Material
Body	Brass CW617N	Plunger	Brass
Spring	AISI 304 stainless steel	Washer	Nitrile butadiene rubber (NBR)

Product Codes & Dimensions

Code	Size (Ga)	Max Pressure	A	B
SPV.1	1/2"	10	45	35
SPV.2	3/4"	10	48	41
SPV.3	1"	10	53	45
SPV.4	1 1/4"	8	67	56
SPV.5	1 1/2"	8	75	65
SPV.6	2"	8	80	80
SPV.7	2 1/2"	6	92	95
SPV.8	3"	6	101	109
SPV.9	4"	6	121	110

P460 Stop Cock

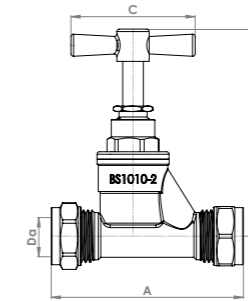

5
Year Warranty

General Specification

Manufactured to:	BS1010-2
Compression Ends:	BS EN1254-2
Pressure Rating:	PN16
Working Temperature:	up to 90°C

Material Specification

Part	Material
Body	Brass CW617N
Drive Column	Brass CW617N
Washer	Nitrile butadiene rubber (NBR)
Bonnet	Brass CW617N
Sealing Ring	PTFE
Locking Ring	Brass CW617N
Handle	Brass CW617N
Screw	Brass CW617N
Olive	Copper
Nut	Brass CW617N

Product Codes & Dimensions

Code	Size (Da)	A	B	C
P460.1	15mm	74	80	51
P460.2	22mm	93	87	54
P460.3	28mm	107	96	62

MDPE Stop Cock

Code	Size (Da, Db)	A	B	C
P460.4	20 x 15mm	74	80	51
P460.5	25 x 22mm	93	87	54

P460 Large Stop Cock

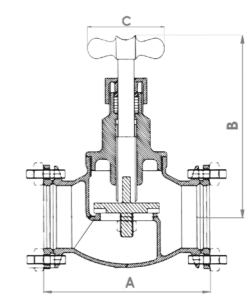

5
Year Warranty

General Specification

Temperature Pressure:	10 Bar @ 30°C
	3 Bar @ 120°C

Product Codes & Dimensions

Code	Size (Da)	A	B
P460.7	67mm	206	194
P460.8	76mm	239	221

P472 & P472CP Isolation Valve

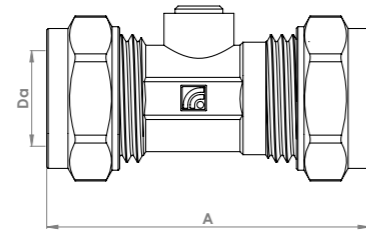

5
Year Warranty

General Specification

Compression Ends: BS EN1254-2
 Working Temperatures: -20°C to 90°C
 Pressure Rating: PN16

Material Specification

Part	Material	Part	Material
Body	Brass CW617N Chrome-plated	Column Sealing rings	Nitrile butadiene rubber (NBR)
Ball	Brass CW617N Chrome-plated	Ball Retainer	AISI 304 Stainless steel
Sealing Rings	Nitrile butadiene rubber (NBR)	Olive	Copper
Drive Column	Brass CW617N Chrome-plated	Nut	Brass CW617N Chrome-plated

Product Codes & Dimensions

Code	Size (Da)	Finish:	A
P472.1	15mm	Brass CW617N	37
P472.2	22mm	Brass CW617N	49
P472CP.1	15mm	Chrome Plate	37
P472CP.2	22mm	Chrome Plate	49

P472CPBH Isolation Valve with Black Handle

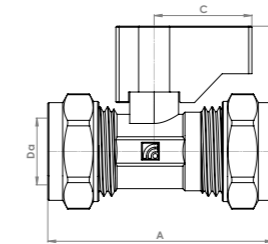

5
Year Warranty

General Specification

Compression Ends: BS EN1254-2
 Working Temperatures: -20°C to 100°C
 Pressure Rating: PN10

Material Specification

Part	Material	Part	Material
Body	Brass CW617N Chrome-plated	Ball Retainer	AISI 304 Stainless steel
Ball	Brass CW617N Chrome-plated	Olive	Copper
Sealing Rings	Nitrile butadiene rubber (NBR)	Handle	Plastic
Drive Column	Brass CW617N Chrome-plated	Screw	Steel
Column Sealing rings	Nitrile butadiene rubber (NBR)		
Nut	Brass CW617N Chrome-plated		

Product Codes & Dimensions

Code	Size (Da)	A	B	C
P472CPBH.1	15mm	60	30	22
P472CPBH.2	22mm	70	32	22

Ball Type Pump Valve

MPF.PV Pump Valve Black Handle

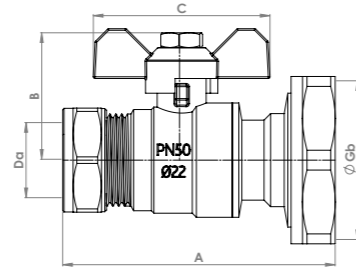

5
Year Warranty

General Specification

Compression End: BS EN 1254-2
 Female End: 1 1/2" Swivel Nut Connection
 Pressure Rating: PN50

Material Specification

Part	Material	Part	Material
Nut	Brass CW617N	Swivel Body	Brass CW617N
Olive	Brass CW617N	Washer	Nitrile butadiene rubber (NBR)
Body	Brass CW617N	Drive Column	Brass CW617N
Sealing Ring	PTFE	O-Ring	Nitrile butadiene rubber (NBR)
Ball	Brass CW614N Chrome-plated	Handle	Aluminium
Swivel Nut	Brass CW617N	Handle Nut	Steel Chrome-plated

Product Codes & Dimensions

Code	Size (Da, Gb)	A	B	C
MPF.PV	22mm x 1 1/2"	83	42	51